

Indice	Date	Modifications	Dessiné par	Contrôlé par
A	14/11/2016	CREATION DE DOCUMENT	O.C.	J.L.A.
B				
C				
D				
E				

Numero de dossier	Phase	Etude	Type	Numero	Ind.
N   0   3   0   0   5   9   -   P   R   O   -   A   S   S   -   V   E   P   -   0   0   1   1   -   A					

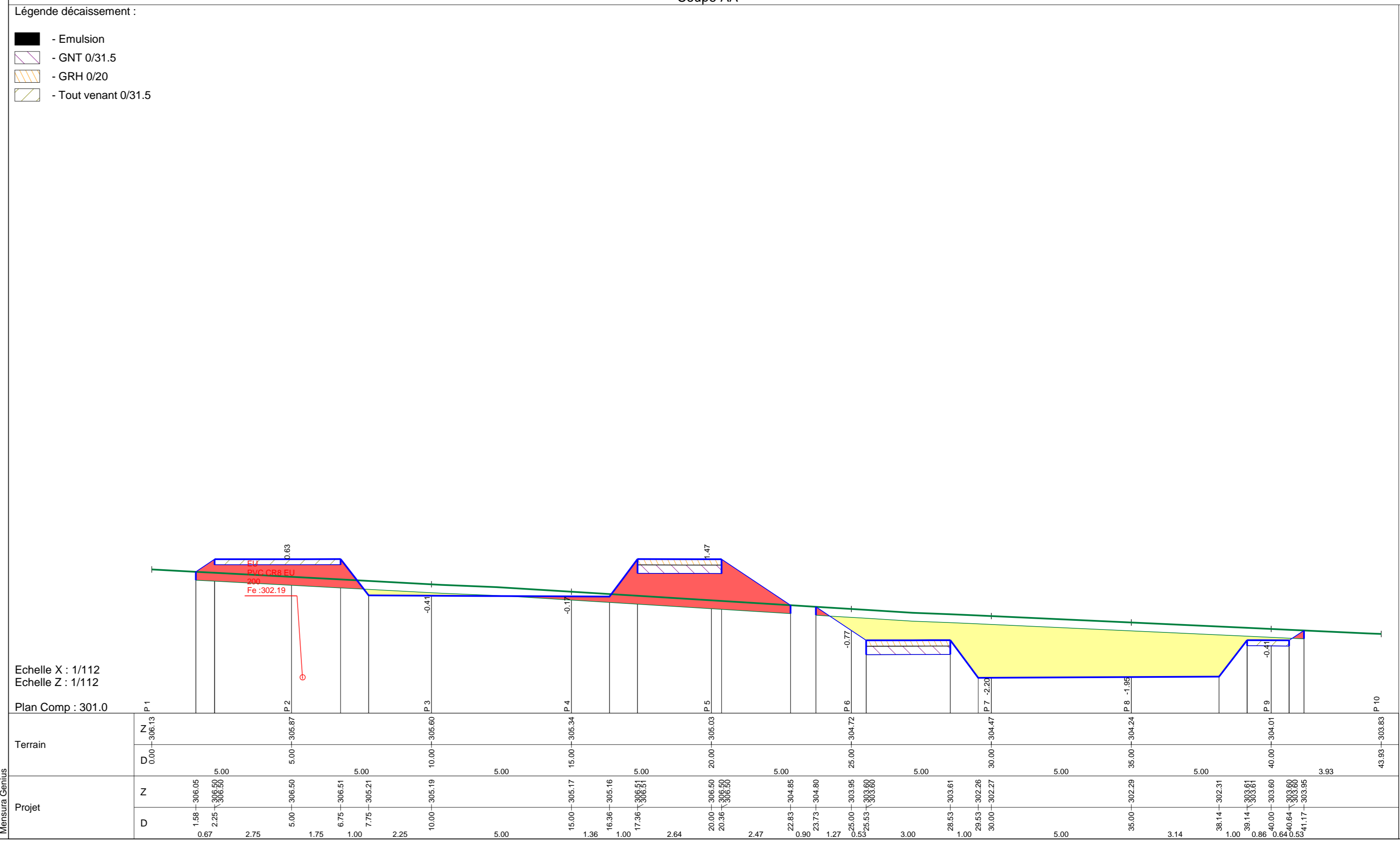
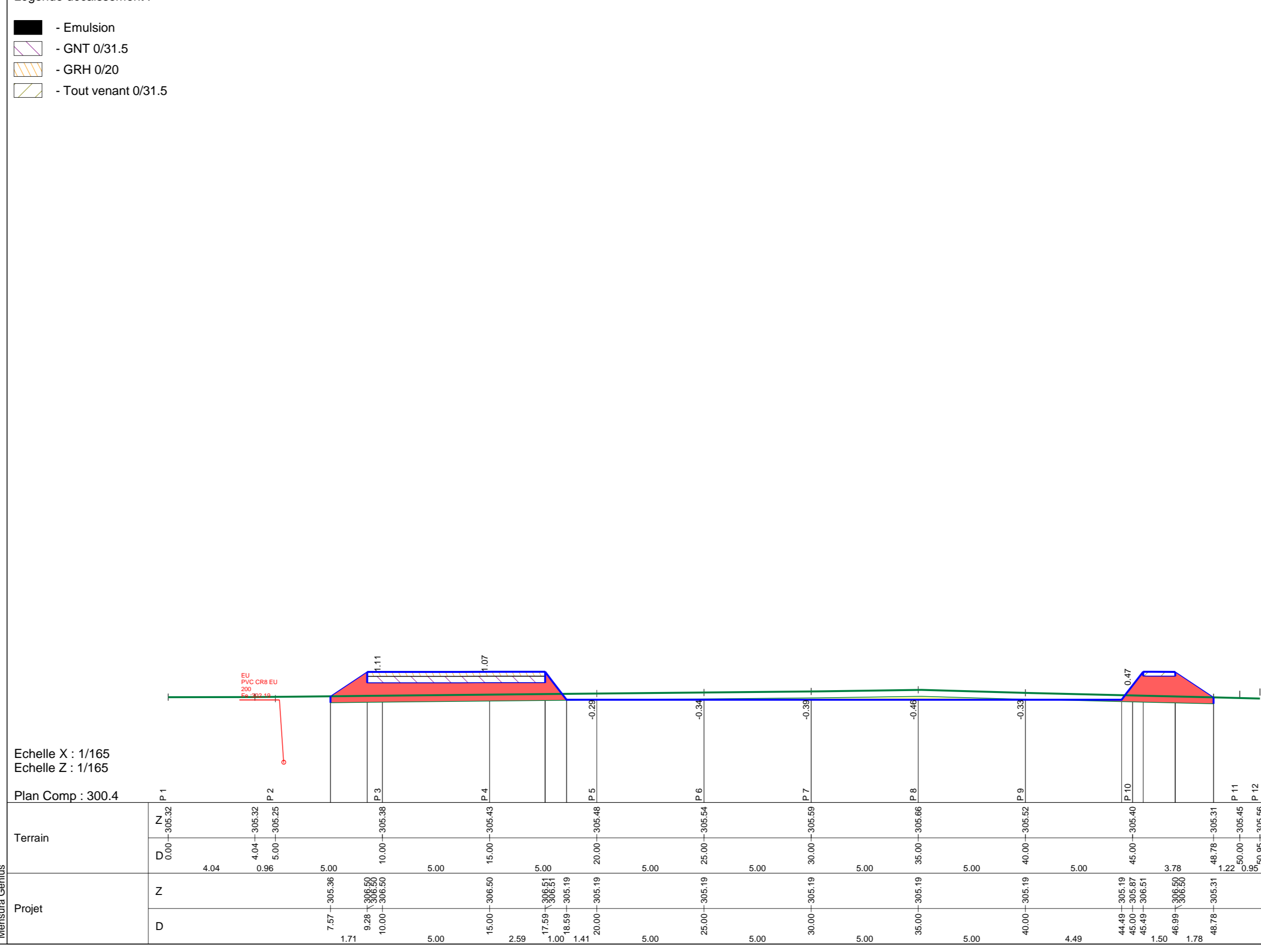
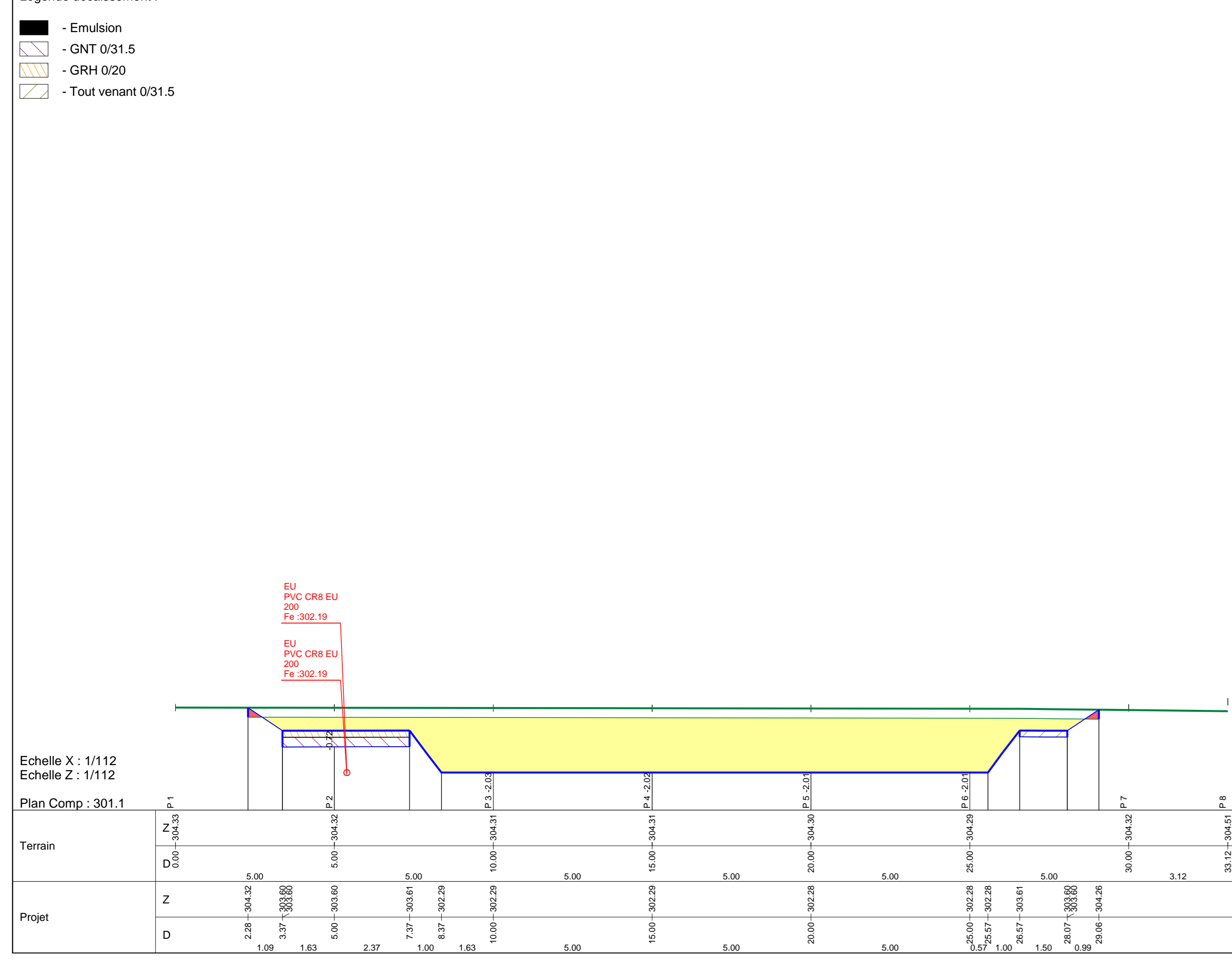
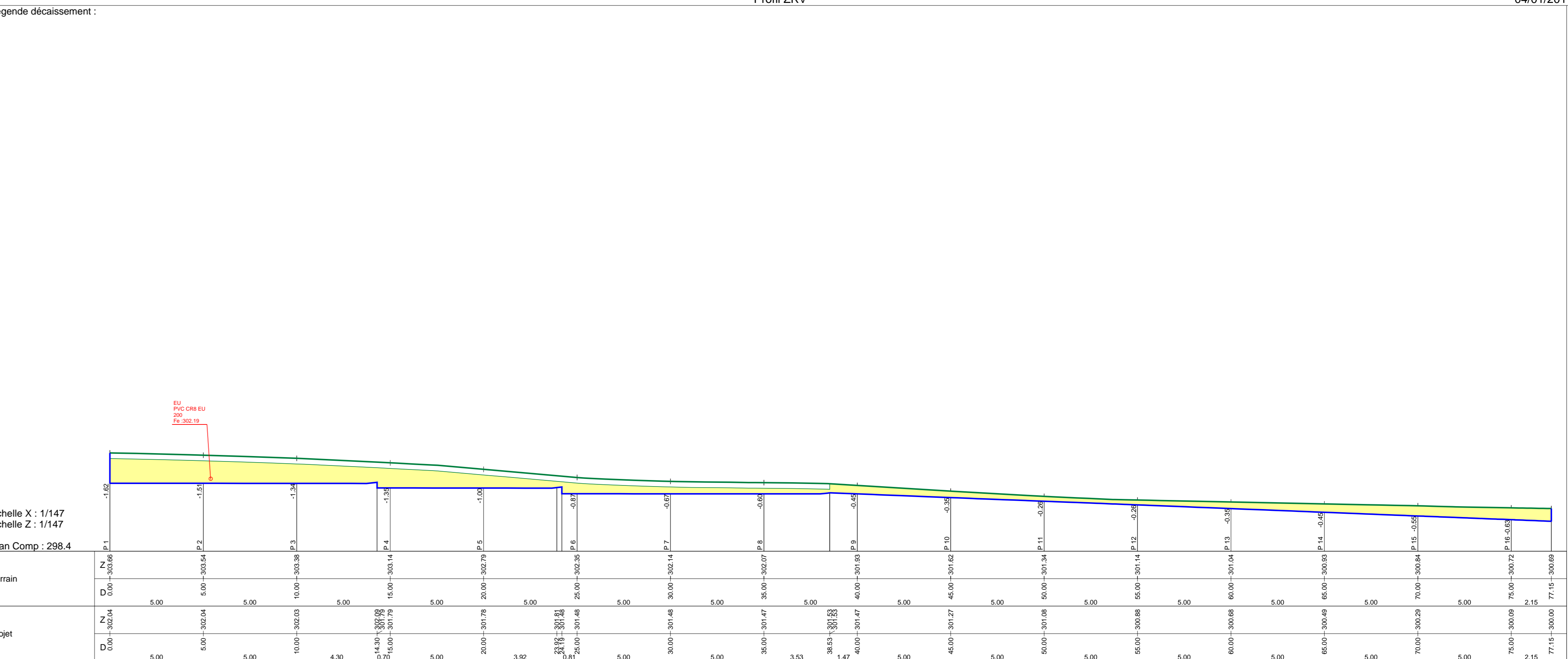
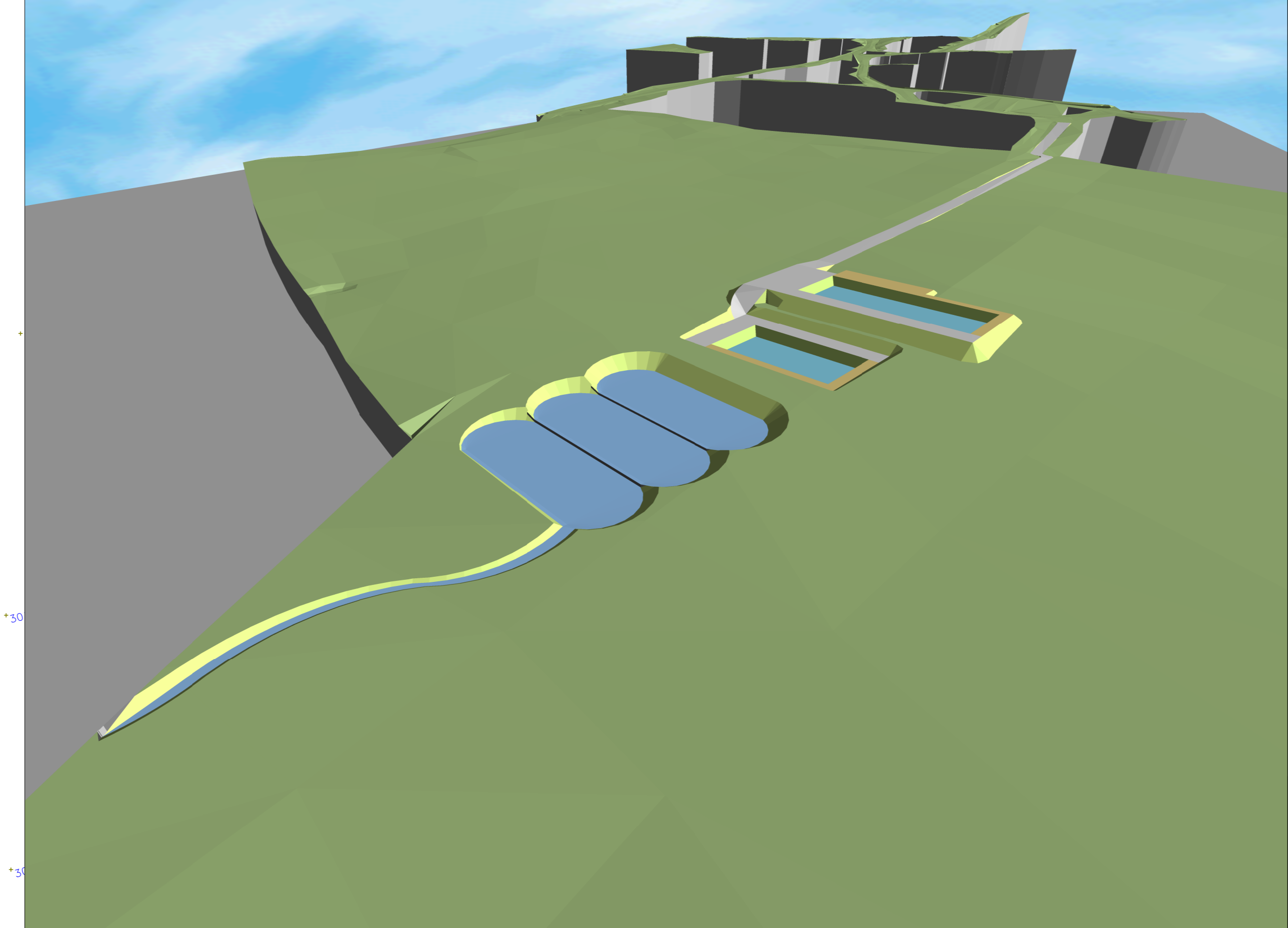
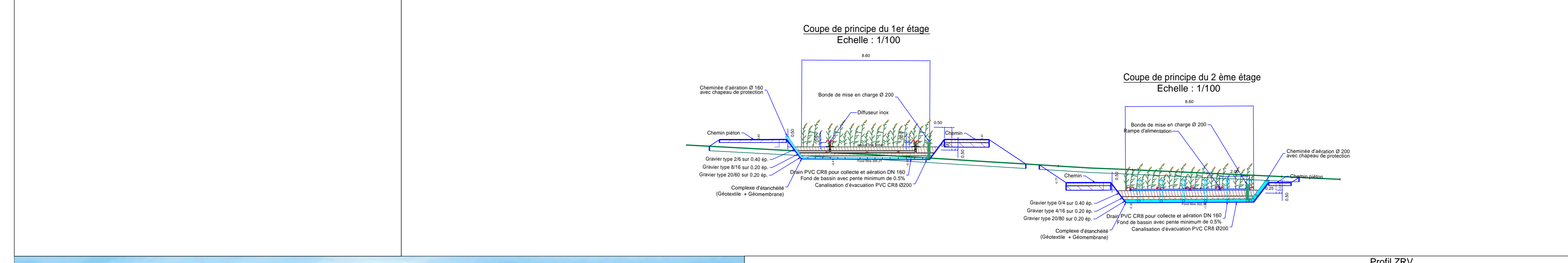
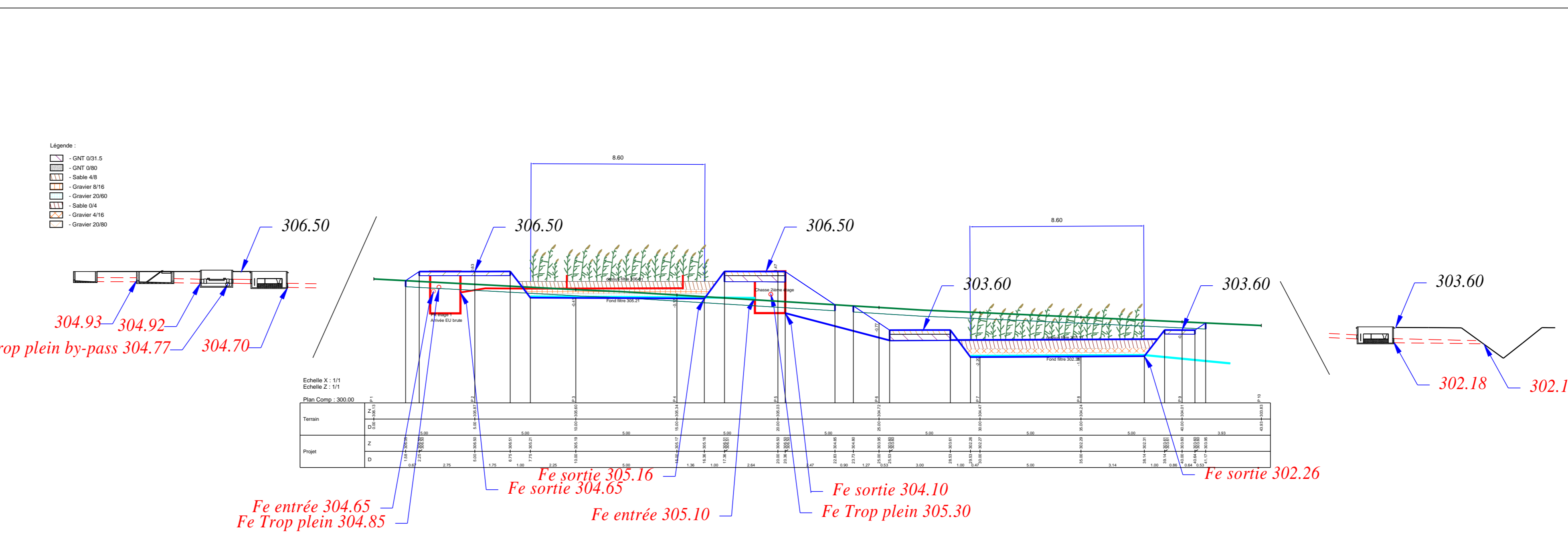
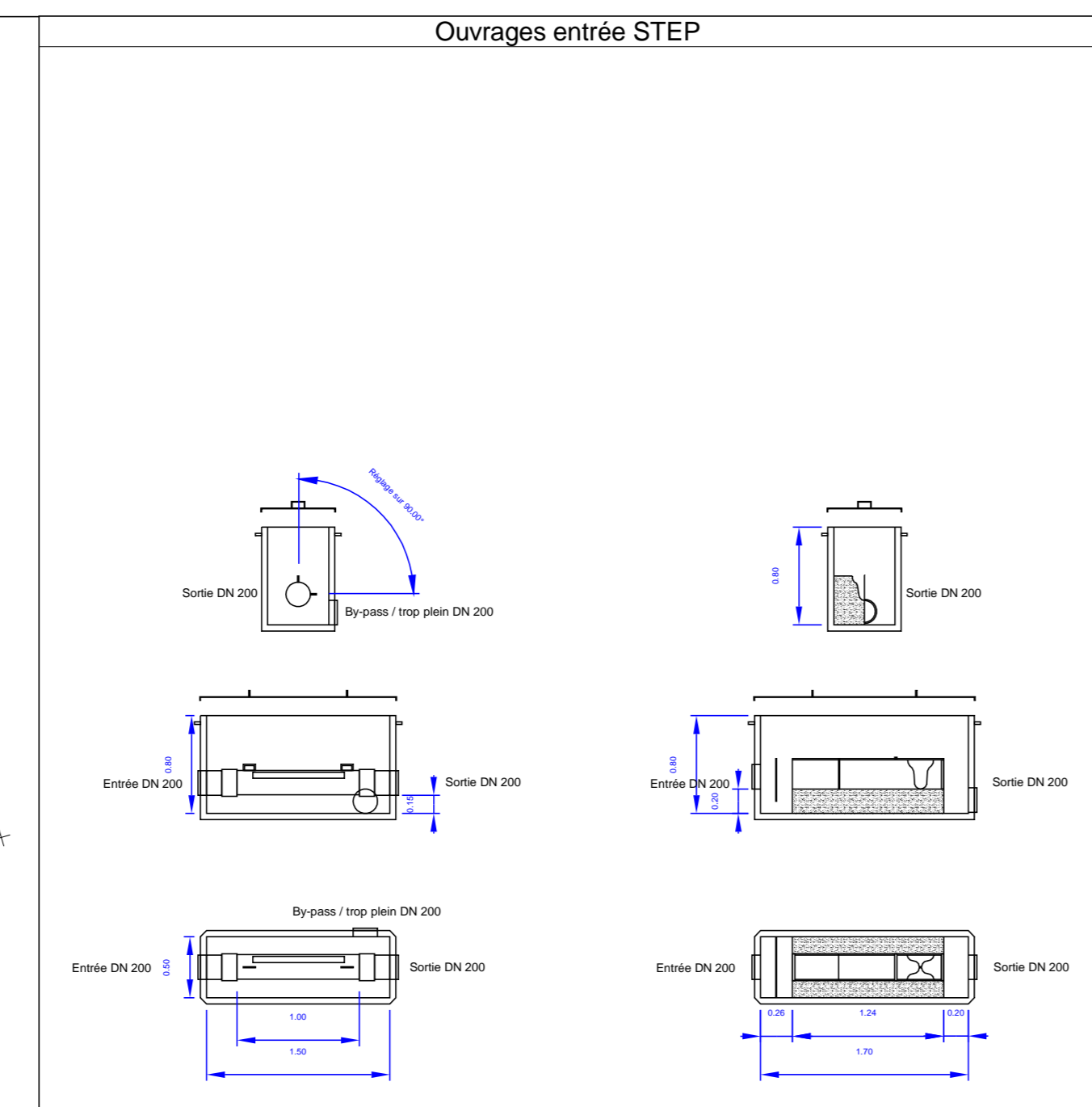
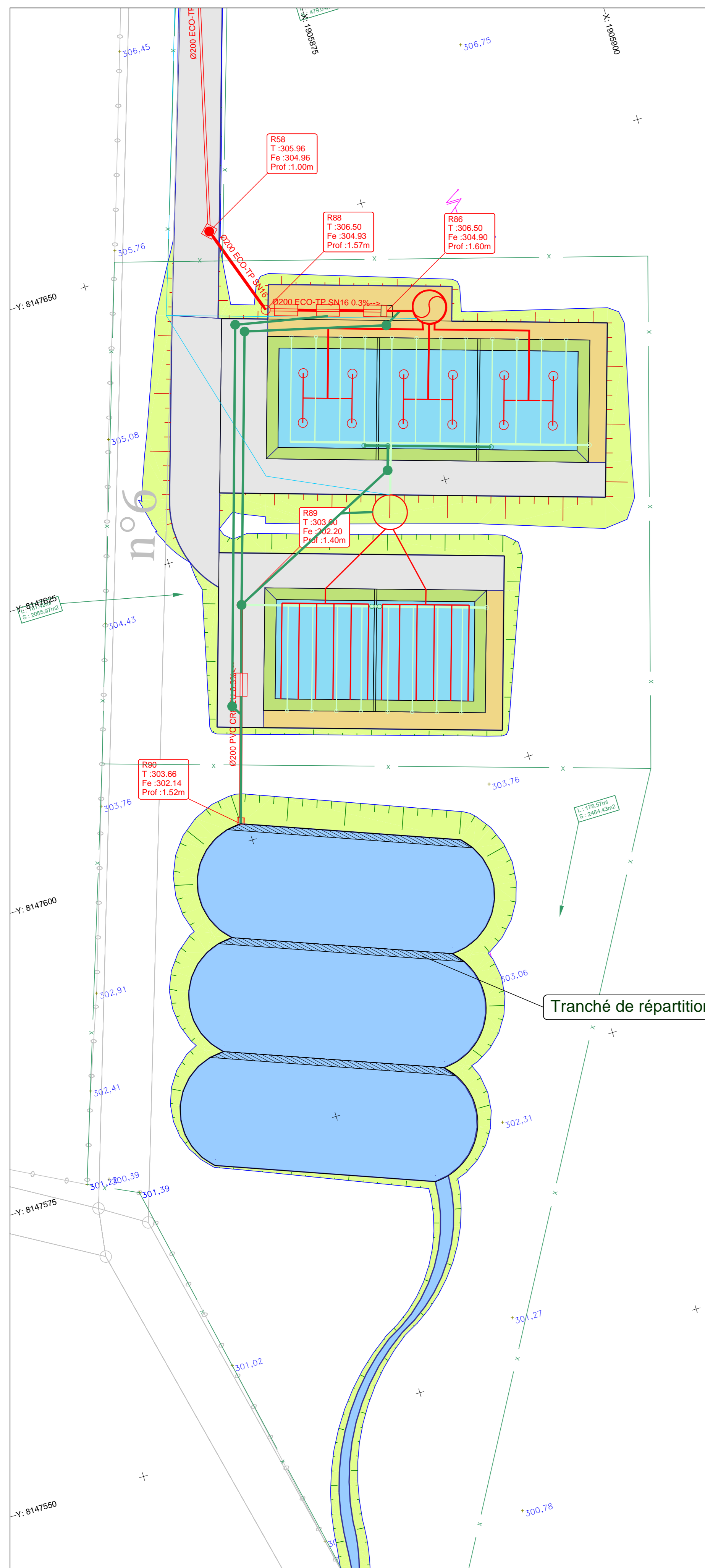

Légende décaissement:

- Emulsion
- GNT 031.5
- GRH 020
- Tout venant 031.5

Légende décaissement:

- Emulsion
- GNT 031.5
- GRH 020
- Tout venant 031.5

Légende décaissement:

- Emulsion
- GNT 031.5
- GRH 020
- Tout venant 031.5